

SECTION A-A

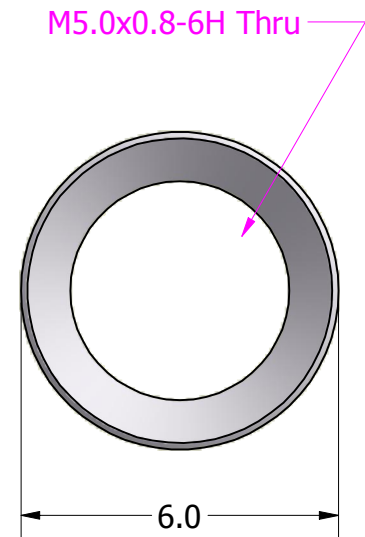

ISO SCALE 3 : 1

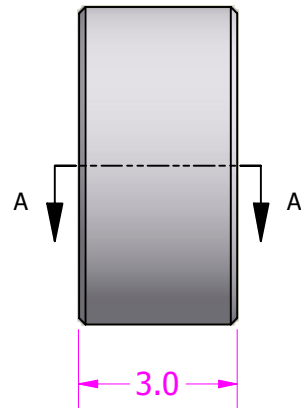

Tolerances Unless Otherwise Specified:

**.x Decimal:** ± 0.3  
**.xx Decimal:** ± .13  
**Fraction:** ± 1/64  
**Angle:** ± 2°

**LYN-TRON, INC.**

Part Number:  
**AA5071-5080-03.0**

Description:  
**6mm Rnd Standoff**

Drawn By:  
**COURTNEYS02/25/2011**

Gauge:

Material:  
**Aluminum (RoHS)**

Scale:  
**7 : 1**