

SECTION A-A

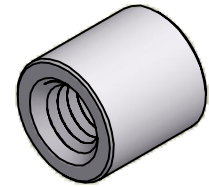

ISO SCALE 3 : 1

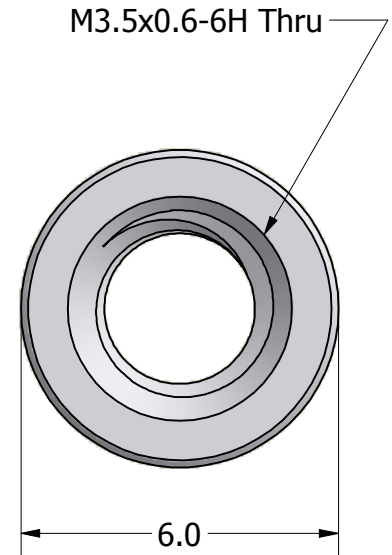
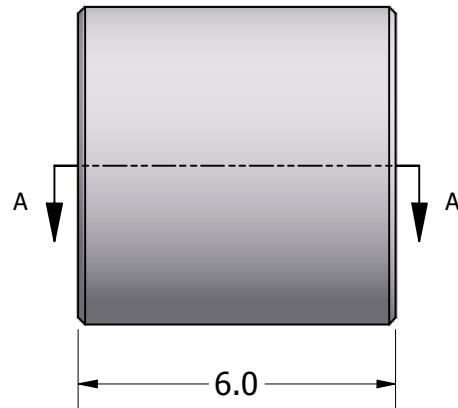

Tolerances Unless Otherwise Specified:

.x Decimal: ± 0.3
.xx Decimal: ± .13
Fraction: ± 1/64
Angle: ± 2°

LYN-TRON, INC.

Part Number:

AA5071-3560-06.0

Description:

6mm Rnd Standoff

Drawn By:

COURTNEYS02/25/2011

Gauge:

Material:

Aluminum (RoHS)

Scale:

7 : 1