

SECTION A-A

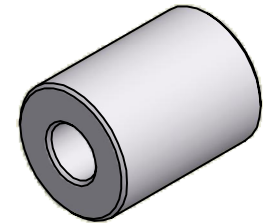

ISO SCALE 2 : 1

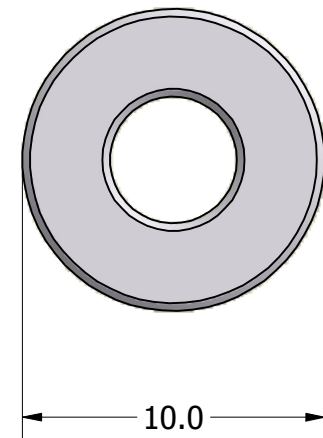
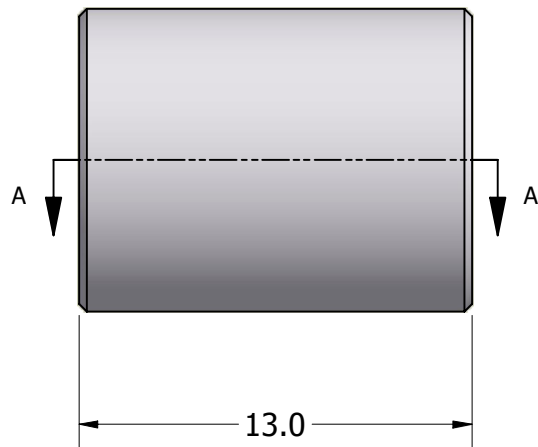

Tolerances Unless Otherwise Specified:

.x Decimal: ± 0.3
 .xx Decimal: ± .13
 Fraction: ± 1/64
 Angle: ± 2°

LYN-TRON, INC.

Part Number:

AA5008-40-13.0

Description:

10mm Rnd Spacer

Drawn By:

JEFFN

06/19/2010

Gauge:

Material:

Aluminum (RoHS)

Scale:

4 : 1